

Bestell-Nr. Order No. Numéro de référence	Staco 31921	Staco 31922	Staco 31923	Staco 31924	Staco 31925	Staco 31926	Staco 31927	Staco 31928	Staco 31929	Staco 31930	Staco 31931		
SW (mm)	65	70	75	80	85	90	95	100	105	110	115		
d2 (mm)	106	113	119	125	131	138	144	150	156	163	169		
L (mm)	138	140	143	150	155	160	160	165	165	170	175		
Preis EUR Price/Prix													

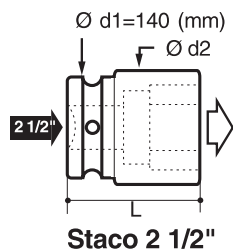

Bestell-Nr. Order No. Numéro de référence	Staco 31932	Staco 31933	Staco 31934	Staco 31935	Staco 31936	Staco 31937	Staco 31938	Staco 31939	Staco 31940	Staco 31941	Staco 31942		
SW (mm)	120	125	130	135	140	145	150	155	160	165	170		
d2 (mm)	175	181	188	194	200	206	213	219	225	231	238		
L (mm)	175	175	180	180	185	185	190	200	205	205	210		
Preis DM Price/Prix													

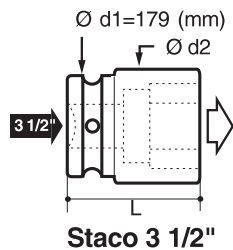

Bestell-Nr. Order No. Numéro de référence	Staco 31961	Staco 31962	Staco 31963	Staco 31964	Staco 31965	Staco 31966	Staco 31967	Staco 31968	Staco 31969	Staco 31970	Staco 31971	Staco 31972	Staco 31973	Staco 31974
SW (mm)	65	70	75	80	85	90	95	100	105	110	115	120	125	130
d2 (mm)	116	122	129	135	141	148	154	160	166	173	179	185	191	198
L (mm)	158	160	163	170	175	180	180	185	185	190	195	195	195	200
Preis EUR Price/Prix														

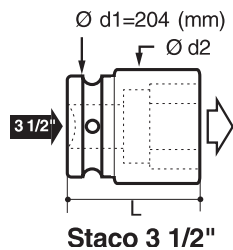

Bestell-Nr. Order No. Numéro de référence	Staco 31975	Staco 31976	Staco 31977	Staco 31978	Staco 31979	Staco 31980	Staco 31981	Staco 31982					
SW (mm)	135	140	145	150	155	160	165	170					
d2 (mm)	204	210	216	223	229	235	241	248					
L (mm)	205	205	205	210	220	225	225	230					
Preis EUR Price/Prix													

	Gummiring Ring Rondelle en caoutchouc	Stift Pin Goujon		
Abtriebsvierkant Square Drive Impulsion Quadrangulaire	Bestell-Nr. Order No. Numéro de réf.	Preis EUR Price Prix	Bestell-Nr. Order No. Numéro de réf.	Preis DM Price Prix
Staco 3/4" Staco-L 3/4"	31620		31621	
Staco 1" Staco-L 1"	31520		31521	
Staco-K 1 1/2" Staco-L 1 1/2"	31420		31421	
Staco 2 1/2"	31425		31426	
Staco 3 1/2"	31427		31428	

alkitronic® - Staco - Set		
Abtriebsvierkant Square Drive Impulsion Quadrangulaire	Bestell-Nr. Order No. Numéro de référence	Preis DM Price Prix
Staco 3/4"	Staco 31600	
Staco-L 3/4"	Staco 31630	
Staco 1"	Staco 31500	
Staco-L 1"	Staco 31530	
Staco-K 1 1/2"	Staco 31400	
Staco-L 1 1/2"	Staco 31430	
Staco 2 1/2"	Staco 31920	
Staco 3 1/2"	Staco 31960	

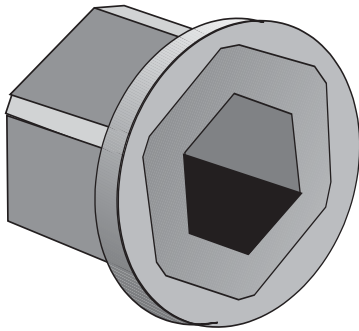

(mm)		Bestell-Nr. / Order No. Numéro de référence	Sta 31705	Sta 31706	Sta 31707	Sta 31708				Sta 31805	Sta 31806	Sta 31807	Sta 31808			
		SW (mm)	24	27	30	32				SW (inch)	31/32"	1 1/16"	1 1/8"	1 1/4"		
		Preis / Price / Prix DM														
(mm)		Bestell-Nr. / Order No. Numéro de référence	Sta 31701	Sta 31702						Sta 31801	Sta 31802					
		SW (mm)	36	41						SW (inch)	1 7/16"	1 5/8"				
		Preis / Price / Prix DM														
(mm)		Bestell-Nr. / Order No. Numéro de référence	Sta 31711	Sta 31712	Sta 31713					Sta 31811	Sta 31812	Sta 31813				
		SW (mm)	36	41	46					SW (inch)	1 7/16"	1 5/8"	1 13/16"			
		Preis / Price / Prix DM														
(mm)		Bestell-Nr. / Order No. Numéro de référence	Sta 31721	Sta 31722	Sta 31723	Sta 31724	Sta 31725			Sta 31821	Sta 31822	Sta 31823	Sta 31824	Sta 31825		
		SW (mm)	36	41	46	50	55			SW (inch)	1 7/16"	1 5/8"	1 13/16"	2"	2 3/16"	
		Preis / Price / Prix DM														
(mm)		Bestell-Nr. / Order No. Numéro de référence	Sta 31731	Sta 31732	Sta 31733	Sta 31734	Sta 31735	Sta 31736		Sta 31831	Sta 31832	Sta 31833	Sta 31834	Sta 31835	Sta 31836	
		SW (mm)	36	41	46	50	55	60		SW (inch)	1 7/16"	1 5/8"	1 13/16"	2"	2 3/16"	2 3/8"
		Preis / Price / Prix DM														
(mm)		Bestell-Nr. / Order No. Numéro de référence	Sta 31741	Sta 31742	Sta 31743	Sta 31744	Sta 31745	Sta 31746		Sta 31841	Sta 31842	Sta 31843	Sta 31844	Sta 31845	Sta 31846	
		SW (mm)	46	50	55	60	65	70		SW (inch)	1 13/16"	2"	2 3/16"	2 3/8"	2 9/16"	2 3/4"
		Preis / Price / Prix DM														
(mm)		Bestell-Nr. / Order No. Numéro de référence	Sta 31861	Sta 31862						Sta 31866	Sta 31867					
		SW (mm)	80	95						SW (inch)	3 1/8"	3 3/4"				
		Preis / Price / Prix DM														

Weitere Größen auf Anfrage
Further sizes upon request
D'autres dimensions après demande

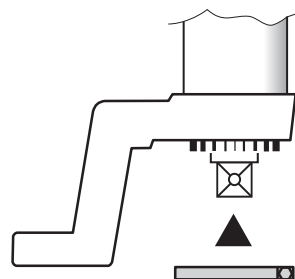
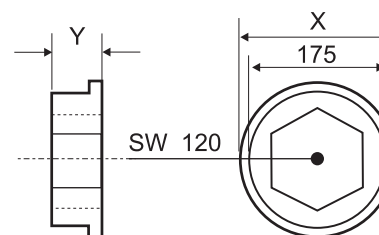
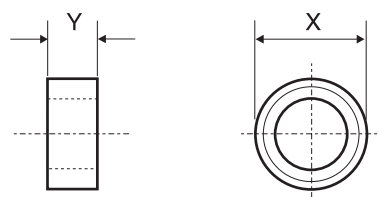
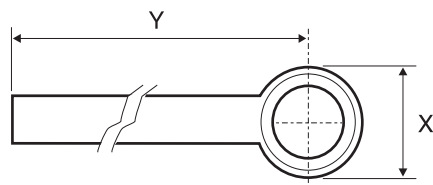
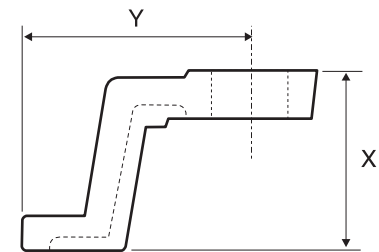
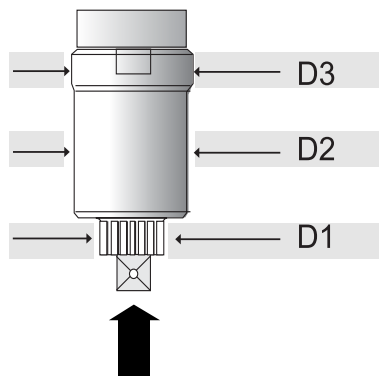

Bei Bestellung bitte Gerätetyp angeben.
Please specify the type of machine when ordering.
Indiquer le type de la machine dans la commande.

Abstützfuß Support arm Bras du support	Durchm./Diam. Longueur Ø D1 D2 D3	Maße ca./Mesures Mesures X mm Y	Bestell-Nr./Order No. Numéro de référence	Preis/Price Prix DM
Abtriebsvierkant Square Drive Impulsion quadrangulaire	1 1/2"	41 85 88	110 130	DMA 10251
	3/4"	41 85 88	110 130	DMA 10251
	3/4"	54 85 88	110 130	DMA 10252
	1"	54 85 88	110 130	DMA 10252
	1"	54 85 88	115 150	DMA 10253
	1 1/2"	72 -- 98	156 220	DMA 10255
	1 1/2"	72 -- 123	170 220	DMA 10256
		72 -- 148	170 220	DMA 10256
		91 -- 173	174 220	DMA 10257

* Für Leistungen über 2000 Nm empfehlen wir den verstärkten DMA 10253
For range higher than 2000Nm we recommend you to use the new reaction arm, stronger one, DMA 10253
Pour couple plus haut que 2000Nm nous vous recommandons d'utiliser le nouveau support de réaction, plus forte, DMA 10253

Gegenhalter Towards support Contre support	Durchm./Diam. Longueur Ø D1 D2 D3	Maße ca./Mesures Mesures X mm Y	Bestell-Nr./Order No. Numéro de référence	Preis/Price Prix DM
Abtriebsvierkant Square Drive Impulsion quadrangulaire	3/4"	41 85 88	65 240	DMA 10261
	3/4"	54 85 88	80 240	DMA 10262
	1"	54 85 88	80 240	DMA 10262
	1 1/2"	72 -- 98	105 240	DMA 10265
	1 1/2"	72 -- 123	105 240	DMA 10266
		72 -- 148	105 240	DMA 10266
		91 -- 173	105 240	DMA 10267

Abstützring Support ring Anneau du support	Durchm./Diam. Longueur Ø D1 D2 D3	Maße ca./Mesures Mesures X mm Y	Bestell-Nr./Order No. Numéro de référence	Preis/Price Prix DM
Abtriebsvierkant Square Drive Impulsion quadrangulaire	3/4"	41 85 88	65 28	DMA 10246
	3/4"	54 85 88	80 28	DMA 10247
	1"	54 85 88	80 28	DMA 10247
	1 1/2"	72 -- 98	110 33	DMA 10248
	1 1/2"	72 -- 123	110 47	DMA 10249
	1 1/2"	72 -- 148	110 47	DMA 10249
	1 1/2"	91 -- 173	130 52	DMA 10250
2 1/2"	SW120	57 180	DMA 10416	

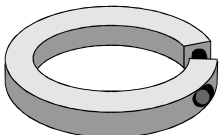
Sicherungsring Security ring Anneau du sécurité	Durchm./Diam. Longueur Ø D1 D2 D3	Bestell-Nr./Order No. Numéro de référence	Preis/Price Prix DM
	41 -- --	DMAR 10271	
	54 -- --	DMAR 10272	
	72 -- --	DMAR 10275	
	91 -- --	DMAR 10277	

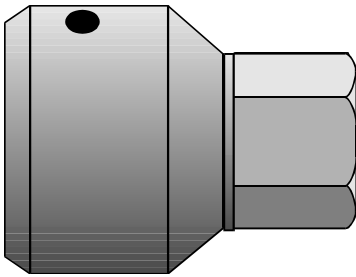

Sämtliche alkitronic®-Stabi werden nach einem Präzisionsverfahren hergestellt. Aus einem Stück - für größte Beanspruchung. Der verschleißfeste Edelstahl mit einer Festigkeit von Schmiedeteilen garantiert höchste Belastbarkeit.
alkitronic®-Standardverbinder - zuverlässig und preiswert. Verwenden Sie künftig alkitronic®

La totalité des alkitronic®-Stabi sont fabriqués pour opérer avec précisions. Un seul outil déploie de grands efforts. Une grande capacité de charge est garantie avec la tension exercée, vue la constitution en acier dur de ses éléments.
alkitronic®, joint de tension, sont authentiques et à bon marché. Vous êtes invités à pratiquer et à s'accomoder au matériel alkitronic® dans le future.

All alkitronic®-Stabis are manufactured using a high-precision technological process. Non-cutting process; manufactured from solid die-cast units; for heavy-duty applications. Collet chuck steel, compacted with the density of forged parts guarantees highest possible resistance to strain.
alkitronic®-standard connectors - reliable and reasonable. Make sure you use alkitronic® in future, too.

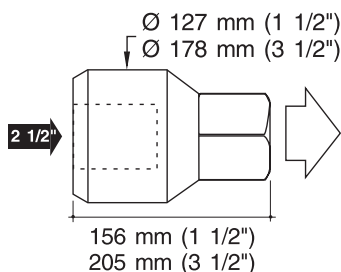
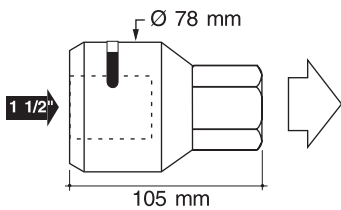
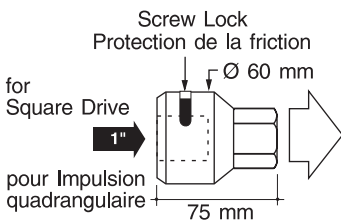
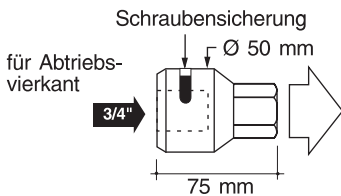

Bestell-Nr. Order No. Numéro de référence	Stabi 31305	Stabi 31306	Stabi 31307	Stabi 31310	Stabi 31311	Stabi 31312	Stabi 31313	Stabi 31314	Stabi 31315	Stabi 31316
	- 1/2" □	- 3/4" □	- 1" □	- 12 mm ○	- 14 mm ○	- 17 mm ○	- 19 mm ○	- 22 mm ○	- 24 mm ○	- 27 mm ○
Preis DM Price/Prix										

Bestell-Nr. Order No. Numéro de référence	Stabi 31205	Stabi 31206	Stabi 31207	Stabi 31210	Stabi 31211	Stabi 31212	Stabi 31213	Stabi 31214	Stabi 31215	Stabi 31216
	- 3/4" □	- 1" □	- 1 1/2" □	- 17 mm ○	- 19 mm ○	- 22 mm ○	- 24 mm ○	- 27 mm ○	- 30 mm ○	- 32 mm ○
Preis DM Price/Prix										

Bestell-Nr. Order No. Numéro de référence	Stabi 31105	Stabi 31106	Stabi 31107	Stabi 31110	Stabi 31111	Stabi 31112	Stabi 31113	Stabi 31114	Stabi 31115	Stabi 31116
	- 1" □	- 1 1/2" □	- 2 1/2" □	- 19 mm ○	- 22 mm ○	- 24 mm ○	- 27 mm ○	- 30 mm ○	- 32 mm ○	- 36 mm ○
Preis DM Price/Prix										

Bestell-Nr. Order No. Numéro de référence	Stabi 31101	Stabi 31102
	- 1 1/2" □	- 3 1/2" □
Preis DM Price/Prix		

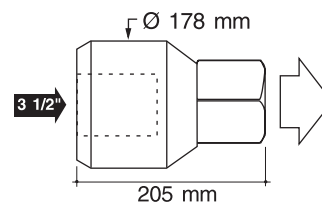

Bestell-Nr. Order No. Numéro de référence	Stabi 31103
	- 2 1/2" □
Preis DM Price/Prix	

Stabi-Set, bestehend aus alkitronic®-Standardverbinder (wie oben) sowie Koffer mit Inneneinrichtung.

Stabi set, consisting of alkitronic® standard connectors, complete with case and protective padding.

L'assortiment Stabi, composé déjà d'alkitronic® joint de tension standard (détaillé ci-dessus) est arrangé dans un coffre.

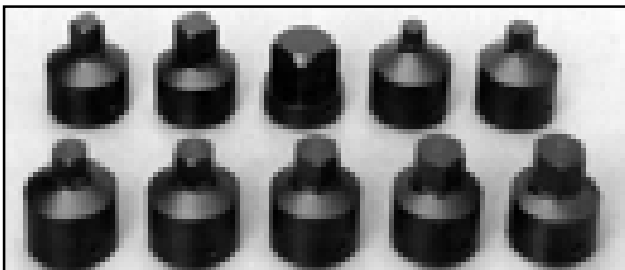

alkitronic® - Stabi-Set	für for pour	Bestell-Nr. Order No. Numéro de référence	Preis DM Price Prix
Abtriebsvierkant Square Drive Impulsion quadrangulaire	3/4"	31320	
	1"	31220	
	1 1/2"	31120	

alkitronic® - Stabhalter/Stabstift

Standardverbinder
Standard connector
Joint de tension standard

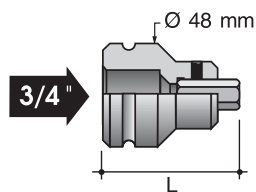
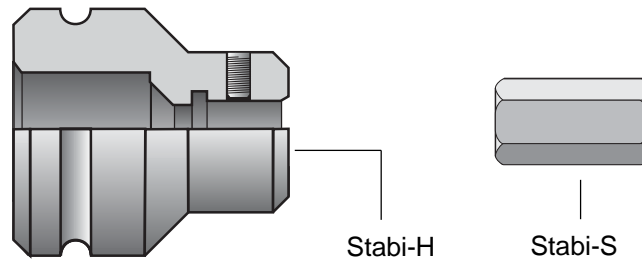

3/4" Bestell-Nr./ Order No. Numéro de référence	Stabi-H 31330	Stabi-H 31331	Stabi-H 31332	Stabi-H 31333	Stabi-H 31334	Stabi-H 31335	Stabi-H 31336		
sw (mm) L (mm)	12 76	14 76	17 76	19 76	22 76	24 76	27 76		
 Bestell-Nr./Order No. Numéro de référence	Stabi-S 31250	Stabi-S 31251	Stabi-S 31252	Stabi-S 31253	Stabi-S 31254	Stabi-S 31255	Stabi-S 31256		

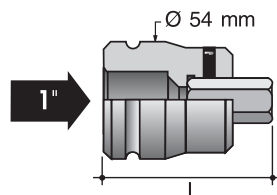

1" Bestell-Nr./Order No. Numéro de référence	Stabi-H 31230	Stabi-H 31231	Stabi-H 31232	Stabi-H 31233	Stabi-H 31234	Stabi-H 31235	Stabi-H 31236		
sw (mm) L (mm)	17 85	19 85	22 85	24 87	27 87	30 87	32 89		
 Bestell-Nr./Order No. Numéro de référence	Stabi-S 31252	Stabi-S 31253	Stabi-S 31254	Stabi-S 31255	Stabi-S 31256	Stabi-S 31257	Stabi-S 31258		

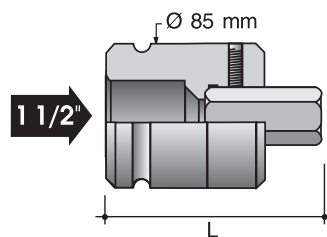

1 1/2" Bestell-Nr./Order No. Numéro de référence	Stabi-H 31130	Stabi-H 31131	Stabi-H 31132	Stabi-H 31133	Stabi-H 31134	Stabi-H 31135	Stabi-H 31136	Stabi-H 31137	Stabi-H 31138	Stabi-H 31139	Stabi-H 31140	Stabi-H 31141	Stabi-H 31142
sw (mm) L (mm)	19 105	22 105	24 105	27 105	30 105	32 105	36 108	41 120	46 122	50 122	55 122	60 122	65 122
 Bestell-Nr./Order No. Numéro de référence	Stabi-S 31253	Stabi-S 31254	Stabi-S 31255	Stabi-S 31256	Stabi-S 31257	Stabi-S 31258	Stabi-S 31259	Stabi-S 31260	Stabi-S 31261	Stabi-S 31262	Stabi-S 31263	Stabi-S 31264	Stabi-S 31265

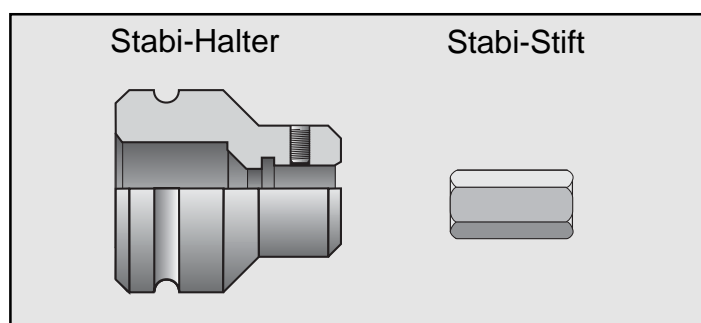

	Gummiring Ring Rondelle en caoutchouc		Stift Pin Goujon	
Antriebsvierkant Square Drive Impulsion Quadrangulaire	Bestell-Nr. Order No. Numéro de réf.	Preis Price Prix	Bestell-Nr. Order No. Numéro de réf.	Preis Price Prix
Stabi-H 3/4"	31620		31621	
Stabi-H 1"	31520		31521	
Stabi-H 1 1/2"	31420		31421	

alkitronic® Drehmoment- schlüssel / Knarre

Torque wrench Ratchet
Clé dynamométrique Cliqué

Drehmomentschlüssel mit automatisch auslösendem akustischem Signal, eingebauter Knarre mit kleinem Nachholwinkel und einfacher sicherer Einstellung des Drehmomentwertes. Bei Verwendung als Antriebsselement für unsere **alkitronic-M** - Handkraftschrauber, werden Drehmomente bis 12.000 Nm, sicher und schnell beherrscht.

Torque wrench gives an audible click when preset torque load is reached. Equipped with a ratchet. Easy and accurate torque setting. Suitable for use with our **alkitronic** - multiplier driver torque output up to 12,000 Nm robust and quick in operation.

La clé dynamométrique prévue avec un signal automatique et cliqué assure un réglage facile du couple. Avec la serreuse manuelle **alkitronic**, elle atteint facilement un couple de serrage jusqu'à 12,000 Nm.



Drehmomentschlüssel

Torque Wrench Clé Dynamométrique

Bestell-Nr. Order No. Numéro de référence	Meßbereich Span / Etendue de Mesure	Abtriebsvierkant Square Drive Impulsion quadrangulaire	Teiltrichskala Scale Échelle	Länge Length Longueur	Gewicht Weight Poids	Preis Price Prix
	Nm		Nm	mm	g	DM
31351	15-90	3/8"	0,5	385	910	
31352	60-360	1/2"	2	490	1115	
31353	70-350	1/2"	10	850	3850	
31354	150-800	3/4"	15	1065	4750	

Knarren rechts bzw. links umschaltbar.

Ratchet right and left reversible

Cliqué droit et gauche réversible



Knarre

Ratchet Cliqué

Bestell-Nr. Order No. Numéro de référence	Abtriebsvierkant Square Drive Impulsion quadrangulaire	Länge Length Longueur	Gewicht Weight Poids	Preis Price Prix
		mm	g	DM
31358	1/2"	250	440	
31359	3/4"	550	2550	
31360	1"	800	4100	

Verbinder Connector / Attache

Bestell-Nr. / Order No. Numéro de référence	31357	31357-K
Preis / Price / Prix		

alkitronic® - Auszug Sonderzubehör

Some special accessories
Accessoires spéciales

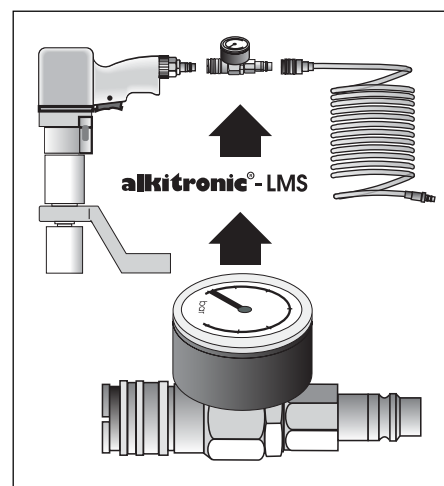
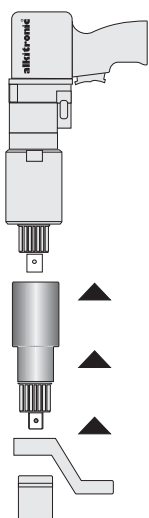

alkitronic® -ATV
Abtriebsverlängerung / Square Drive Extention /
Rallonge d'entraînement

Für weitere Informationen, fordern Sie
unsere Unterlagen an / For further
informations contact us / Pour plus des
informations détaillées nous vous prions
de nous contacter

alkitronic® -Schraubmaschinen
Aufhängung / Hanging device /
Anneau de suspension

alkitronic® -LMS
Luftdruckmess-System /
Air pressure measuring system /
Systeme de mesure d'air

Technische Änderungen vorbehalten · Specifications subject to change without notice · Ces données peuvent être changées

ZUB123/alki/P/1.2.3/0100/R

alki
TECHNIK
GmbH
GERMANY

Münchener Straße 53
D-85051 Ingolstadt
Telefon 08 41 / 9 74 99-0
Telefax 08 41 / 7 50 41
e-Mail: alkitechnik@t-online.de
<http://www.alkitechnik.de>